

**MQ15-X-Power female 90° left, with cable**

PVC 4x1,5 bk UL/CSA 3,0m

Female 90°

MQ15, 4-pole

without cable sleeves

Plastic housings with good resistance against chemicals and oils.

The resistance to aggressive media should be individually tested for your application. Further details on request.

Further cable lengths on request.

**[Link to Product](#)**

**Illustration**

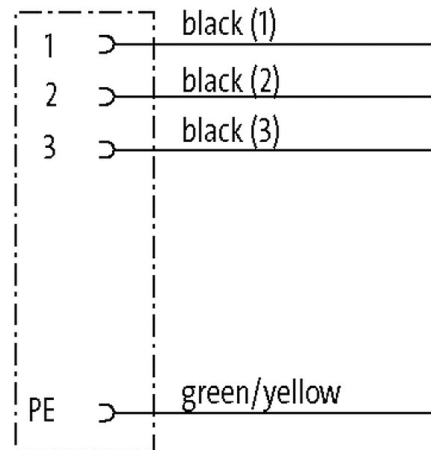
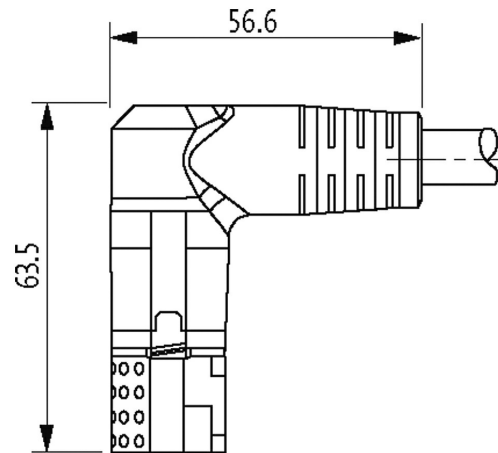
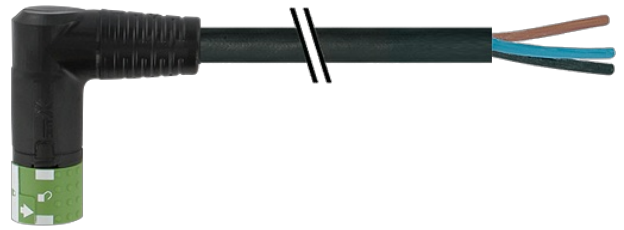

Female

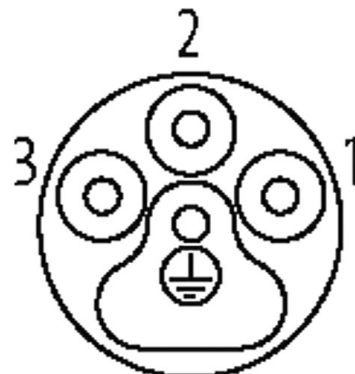

Product may differ from Image

**Form**

|                               |  |
|-------------------------------|--|
| Form                          | P8232                                    |
| <b>General data</b>           |  |
| Mounting method               | inserted, tightened                      |
| Material (contact carrier)    | PA                                       |
| Material (contact)            | Copper alloy                             |
| Material (contact surface)    | Ag                                       |
| Pollution Degree              | 3  |
| Stripping length (jacket)     | 30 mm                                    |
| Temperature range             | -25...+80 °C, depending on cable quality |
| <b>Cables</b>                 |  |
| Cable number                  | P22                                      |
| No./diameter of wires         | 4 × 1.5 mm <sup>2</sup>                  |
| Wire isolation                | PP (bk num, gnye)                        |
| Jacket Color                  | black                                    |
| Material (jacket)             | PVC (UL)                                 |
| Outer Ø                       | 7.4 mm ±5%                               |
| Bend radius (moving)          | 15 × outer Ø                             |
| Temperature range (mobile)    | -5...+80 °C                              |
| Temperature range (fixed)     | -20...+80 °C                             |
| Cable identification          | P22                                      |
| Material (wire)               | Cu wire, bare                            |
| Resistor (core)               | max. 13.3 Ω/km (20 °C)                   |
| AWG                           | similar to AWG 16                        |
| Color/numbering of wires      | bk numbered, gnye longitudinally striped |
| Shield                        | no                                       |
| Material (jacket)             | PVC                                      |
| Outer-Ø (jacket)              | 7.4 mm ±5%                               |
| Color (jacket)                | black                                    |
| thermal resistance            | flame retardant                          |
| Nominal voltage               | 1000 V AC                                |
| Test voltage                  | 4000 V                                   |
| Temperature range (fixed)     | -20...+80 °C                             |
| Bend radius (fixed)           | 5 × outer Ø                              |
| <b>Technical Data</b>         |  |
| Operating voltage             | max. 600 V AC                            |
| Rated surge voltage           | 4.0 kV                                   |
| Operating current per contact | max. 13 A                                |
| Material group                | IEC 60664-1, category I                  |
| No. of poles                  | 4  |
| Configuration                 | fully used                               |
| LED display                   | no                                       |
| Locking of ports              | Quick connection, 1/4 turn               |
| Protection                    | IP67 inserted and tightened (EN 60529)   |
| Material                      | Flame retardant plastic acc. to (UL 94)  |
| Mating cycles                 | ≥ 500                                    |
| <b>Commercial data</b>        |  |
| country of origin             | DE                                       |

|                       |               |
|-----------------------|---------------|
| customs tariff number | 85444290      |
| EAN                   | 4048879707312 |
| eClass                | 27279218      |
| Packaging unit        | 1             |